

E Series Touch Panel (dimming) E1S-TD

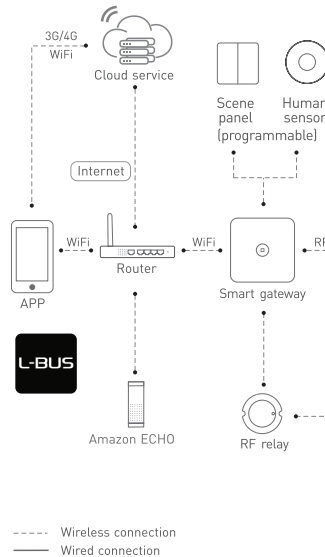

Manual
www.ltech-led.com

System Diagram L-BUS



E1S-TD Touch Panel

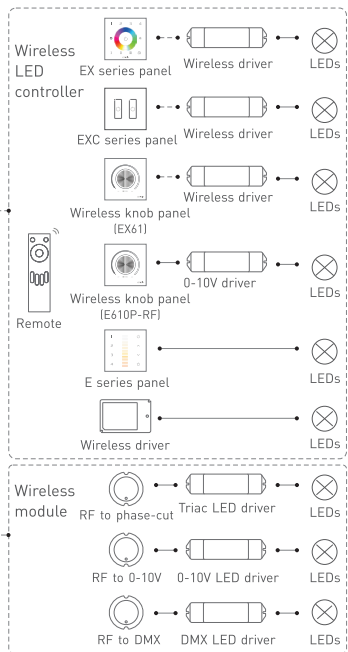

Product Features

- 2 in 1 function: RF wireless control and touch panel control.
- Trailing edge signal output, lamps can be connected directly, easy and convenient.
- Touch keys with chord and LED indicator.
- Adopts capacitive touch control technology on the panel, makes LED color selection more user-friendly.
- Touch panel can be controlled by remote directly or smart phone if add a gateway.

Technical Specs

E1S-TD	Touch panel	
Input voltage:	100~240Vac	Working temp.: -20°C~50°C
Frequency range:	50/60Hz	Dimensions: L86×W86×H36(mm)
Wireless signal:	RF 2.4GHz	Package size: L113×W112×H50(mm)
Dimming mode:	Trailing edge (ELV)	Weight(G.W.): 225g
Working current:	Max. 1A	
Load power:	Max. 200W	
Load inrush current:	Max. 60A	



Installation Instruction

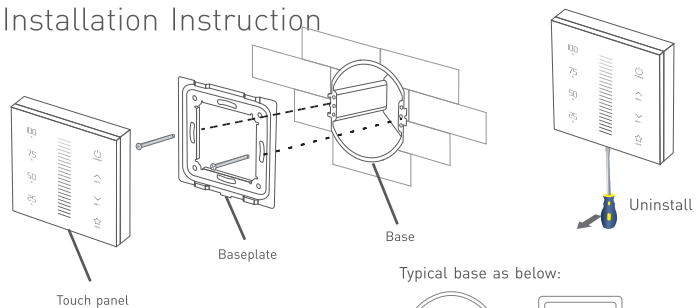

Typical base as below:

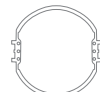

European style



86 size

Product Size

Unit: mm

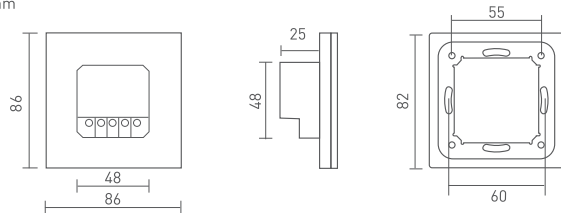

Key Functions

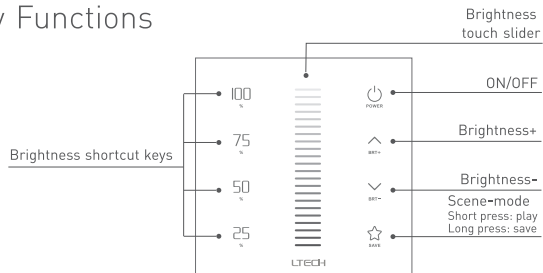

* When blue indicator light of key is on, long press to turn on/off buzzer.
When white indicator light of key is on, long press to match code.

Terminals

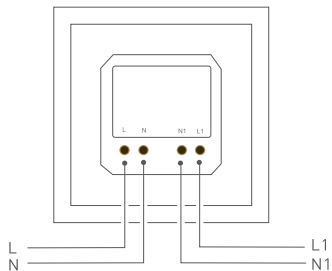

Wiring Diagram

Connect with lamps:

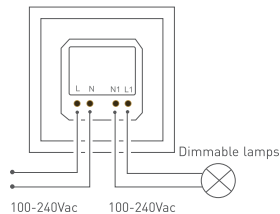

Connect with driver:

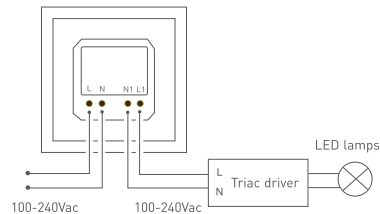

Application Composition

1. +
 Touch panel Lamps or driver
2. + +
 Remote Touch panel Lamps or driver
3. + +
 WiFi gateway Touch panel Lamps or driver
4. + + +
 WiFi gateway Remote Touch panel Lamps or driver

RF Wireless Wiring

Single zone control



Single zone remote F1

Multiple zones control

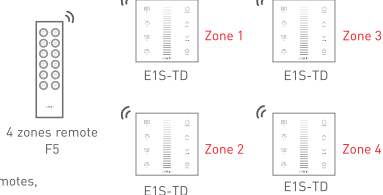

4 zones remote F5

* Touch panels can be sync controlled by multi remotes, please refer to the manual of remote's usage.

Match Code between Touch Panel & Remote

1. Long press on touch panel until all indicator lights flicker.



2. Long press "ON/OFF" key on F1 remote (or long press the matching zone's "ON" & "OFF" key on F5 simultaneously, the indicator lights stop flicking, match successfully.



Match Code between Touch Panel & L-BUS Gateway

1. Long press on touch panel until all indicator lights flicker.

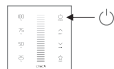

2. Turn on APP, enter "zone set" interface, click the right top "MATCH" key, then follow the prompts.



Clear Code

Press the bottom two keys on touch panel simultaneously for 6 seconds, the indicator light flicker several times, clear code successfully.

* Please match/clear code when indicator light of panel is white.

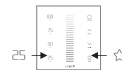

Warranty Agreement:

1. We provide lifelong technical assistance with this product:
 - A 5-year warranty is given from the date of purchase. The warranty is for free repair or replacement if cover manufacturing faults only.
 - For faults beyond the 5-year warranty, we reserve the right to charge for time and parts.
2. Warranty exclusions below:
 - Any man-made damages caused from improper operation, or connecting to excess voltage and overloading.
 - The product appears to have excessive physical damage.
 - Damage due to natural disasters and force majeure.
 - Warranty label, fragile label and unique barcode label have been damaged.
 - The product has been replaced by a brand new product.
3. Repair or replacement as provided under this warranty is the exclusive remedy to the customer. LTECH shall not be liable for any incidental or consequential damages for breach of any stipulation in this warranty.

* No further notice if any changes in the manual.
Product function depends on the goods.
Please feel free to contact our official distributor if any question.